

TYPE	OUTPUT		POLE	TIME RATING	VOLTAGE V	Hz	SYN. SPEED R. P. M
	HP.	KW.					
AEEAGD	350	261	6	CONT.	460	60	1200

TOTALLY ENCLOSED FAN-COOLED TYPE. SQUIRREL-CAGE ROTOR

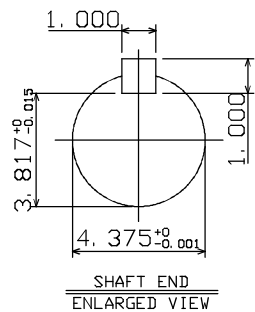
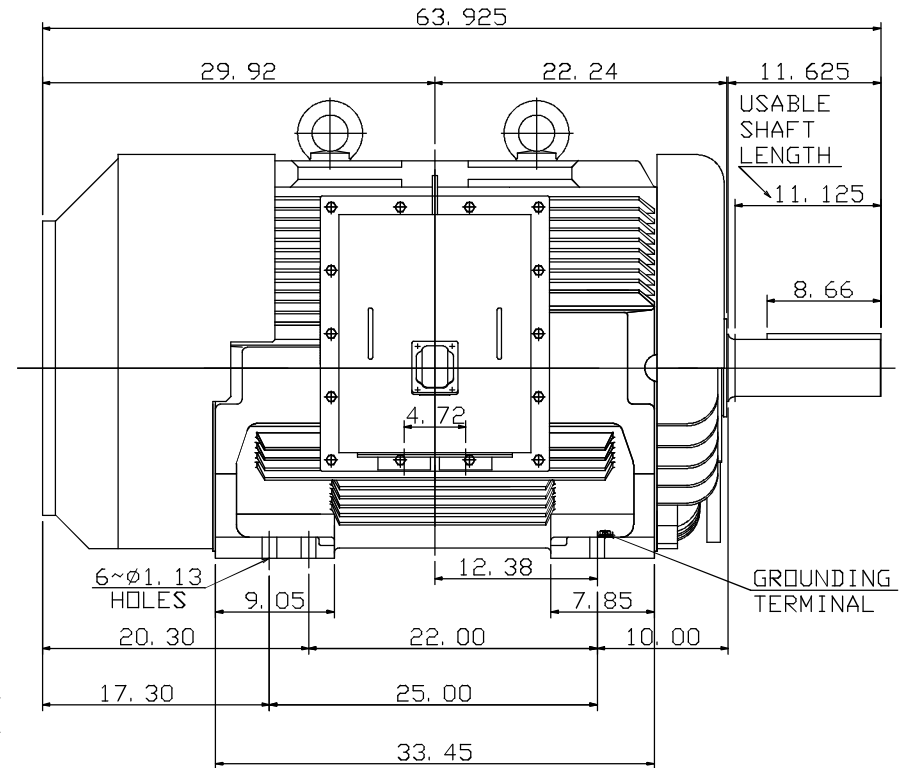
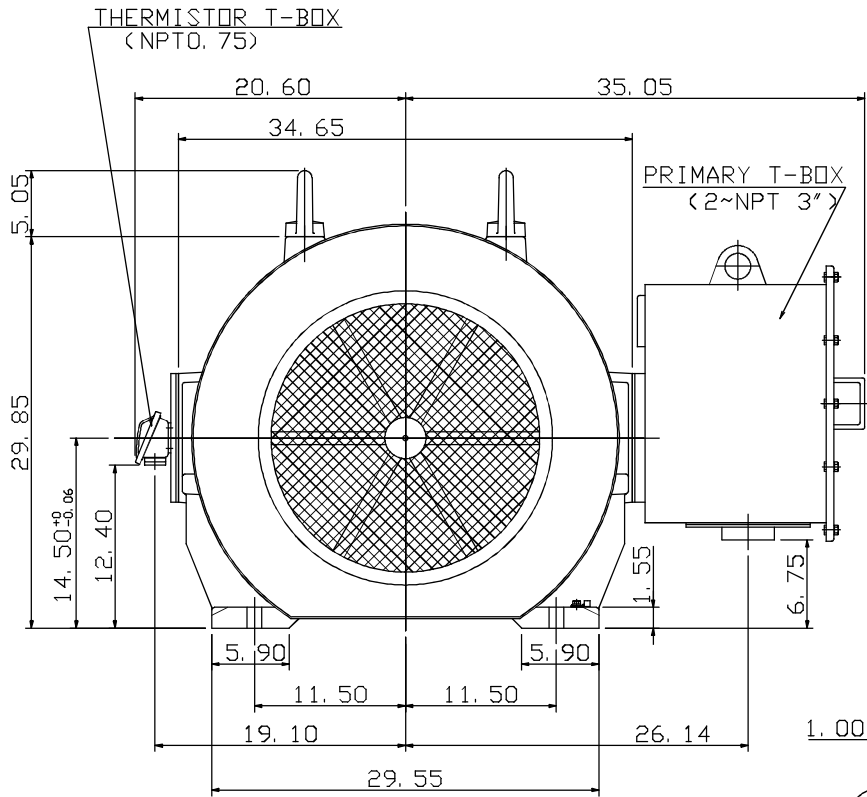

NOTE:

1. DIMENSIONS IN INCHES
2. FRAME NO. 586/7UZ
3. F CLASS INSULATION, S. F. 1.0 (50Hz)
F CLASS INSULATION, S. F. 1.15 (60Hz)
4. FOR BELT SERVICE
5. BEARING SIZE: DRIVE END: NU326C3
NON-DRIVE END: 6322C3
6. ENCLOSURE: IP55
7. WITH THERMISTOR: PTC 140°C 3PCS
8. SHAFT MATERIAL: SCM440 Q&T (AISI 4140 EQUIV)
9. MOTOR APPROX. WEIGHT: 4500 LBS

4A040Y700

DWN.	C. RAM	DEC 02 2015
DWN.	J. CHANG	APR 22 2015
CHKD.	H. HUANG	APR 22 2015
APPD.	C. LIU	APR 22 2015

CATALOG NO.
CD3506RZ

TEC Westinghouse

OUTLINE DIMENSIONS
3-PHASE INDUCTION MOTOR

DWG NO. REV: 00
4B040L197