

TYPE	OUTPUT		POLE	TIME RATING	VOLTAGE V	Hz	SYN. SPEED R. P. M
	HP.	KW.					
AEEAGD	350	261	4	CONT.	460	60	1800

TOTALLY ENCLOSED FAN-COOLED TYPE. SQUIRREL-CAGE ROTOR

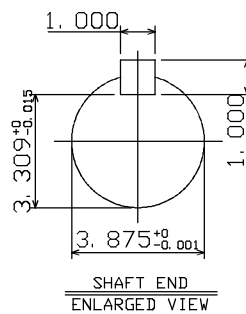
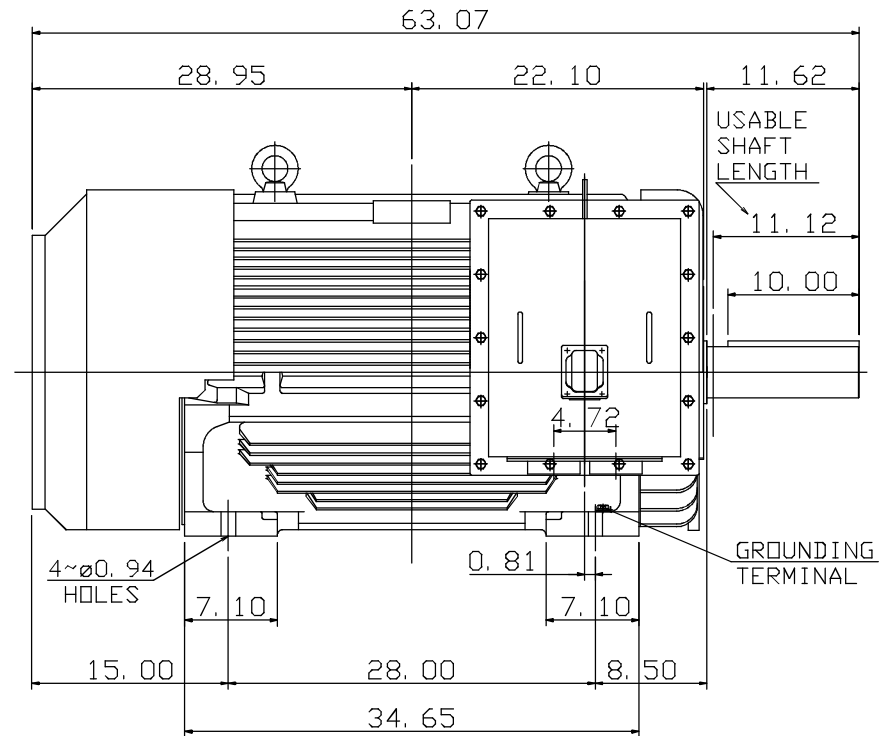
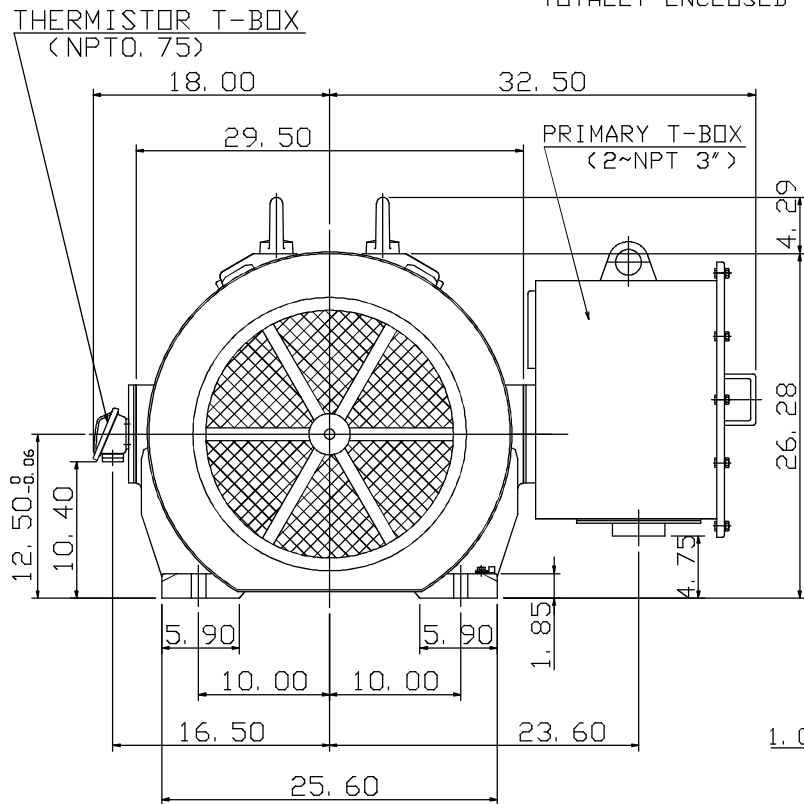

NOTE:

- DIMENSIONS IN INCHES
- FRAME NO. 5009C
- F CLASS INSULATION, S. F. 1.0 (50Hz)
F CLASS INSULATION, S. F. 1.15 (60Hz)
- FOR BELT SERVICE
- BEARING SIZE: DRIVE END: NU324C3
NON-DRIVE END: 6320C3
- ENCLOSURE: IP55
- WITH THERMISTOR: PTC 140°C 3PCS
- SHAFT MATERIAL: SCM440 Q&T (AISI 4140 EQUIV)
- MOTOR APPROX. WEIGHT: 3550 LBS

4A040Y699

DWN.	C. RAM	DEC 02 2015
DWN.	H. CHANG	MAR 03 2015
CHKD.	H. HUANG	MAR 03 2015
APPD.	C. LIU	MAR 03 2015

CATALOG NO.
CD3504R

TEC Westinghouse

OUTLINE DIMENSIONS
3-PHASE INDUCTION MOTOR

DWG NO. REV: 00
4A040Y689